

### Product Overview

The KEF Ventura 4 is a high-performance all-weather speaker designed for outdoor applications including direct exposure to sun, rain, and salt spray. The speaker features a 115mm low frequency woofer and a 19mm fluid cooled aluminium high frequency tweeter mounted in a sealed IP65 certified enclosure ensuring high quality music experiences in even the most extreme atmospheric conditions. Its performance and design characteristics make the KEF Ventura 4 the ideal choice for installations around swimming pools, patios, outdoor gardens, theme parks, car parks, and on yachts.



### Key Features

**Weatherproof Construction** – Manufactured using a proprietary plating and powder coating process, the KEF Ventura 4 had to endure 1,200 hours of direct salt spray testing and is UV protected to withstand the harshest environments with an operating temperature from -40° to +70°C.

**Versatile Mounting System** – An included ratcheting aluminium mounting bracket allows the speaker to be rotated 180° and the symmetrically square KEF logo can be rotated in 90° increments increasing installation options while retaining the correct finished appearance. The speaker also includes ¼-20 brass inserts for use with many aftermarket mounting systems.

**Stainless Steel / Brass Hardware** – The included hardware is made from materials designed to withstand the same extreme operating conditions as the speaker, ensuring the complete assembly is kept free of corrosion and discoloration.

**Fluid Cooled Aluminium Tweeter** – The high-power anodised aluminium tweeter is cooled by a ferro-fluid liquid greatly improving it's thermal handling capacity and reliability.

**IP65 Certification** – The speaker assembly is completely sealed from dust and water ensuring that even direct salt spray will not harm any components.

### Architect and Engineer Specifications

The speaker shall be designed for outdoor installations in extreme atmospheric conditions and utilise a 115mm low frequency woofer and a 19mm liquid cooled and anodised aluminium high frequency tweeter. The speaker enclosure shall be made of ABS, be treated with a UV protective finish, and have dimensions of no more than 231mm x 172mm x 173mm with a total weight of no more than 2.4kg. All supplied mounting brackets and hardware shall be constructed from aluminium, stainless steel, or brass, and support speaker installation in both vertical and horizontal configurations. The speaker shall also include ¼ - 20 inserts for compatibility with aftermarket mounting systems and be available in both black and white finishes.

The speaker shall have a frequency response of 75Hz - 20kHz and an operating temperature range of -40°C to 70°C. The speaker shall achieve a minimum pressure sensitivity of 101dB SPL at 1 meter on-axis with an input signal of 2.83 volts. The crossover frequency between the woofer and tweeter shall be 3.5kHz. The speaker shall be IP65 certified and meet numerous safety and performance standards listed by regulatory bodies around the world.

The speaker shall be the KEF Ventura 4.

## Specifications

Model	<b>Ventura 4</b>	
Series	Ventura	
Nominal impedance	6Ω	
Sensitivity (2.83V/1m)	88dB	
Frequency response (±6dB)	85Hz - 20kHz	
Frequency range (-10dB)	65Hz - 25kHz	
Nominal coverage (degrees)	120°	
Max SPL (dB)	101dB	
Crossover frequency	3.5kHz	
Drive units	LF	115mm (4.5in.)
	HF	19mm (0.75in.)
Recommended amplifier power	10 - 80W	
Recommended high-pass filter (Hz)	80Hz	
Transformer taps	-	
Product external dimensions (H x W x D)	Cabinet only	231 x 172 x 173 mm (9 x 6.75 x 6.8 in.)
	With bracket and knobs	235 x 172 x 203.2 mm (9.25 x 6.75 x 8 in.)
Net weight	2.4kg (5.3lbs)	
Operating temperature range	-40°C to 70°C (-40°F to 158°F)	
Certification	IP65	

Visit [KEF.COM](https://www.kef.com) for more about KEF and its products.

KEF reserves the right, in line with continuing research and development, to amend or change specifications. E&OE.

The Ci speakers that utilise THX in the model name have undergone and passed certified THX approval.

# Ventura 4

## Architectural Speaker



OBSESSED WITH HIGH RESOLUTION

### Directivity Index

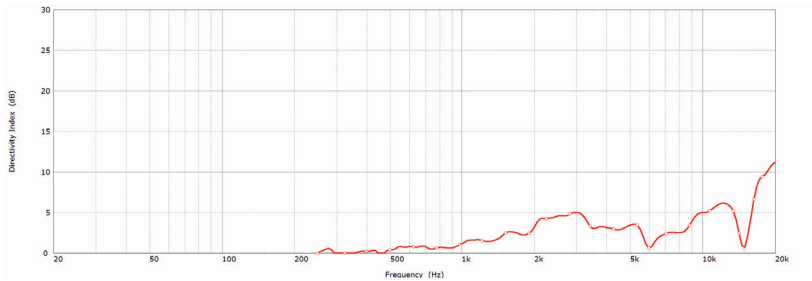

### Beamwidth -3dB

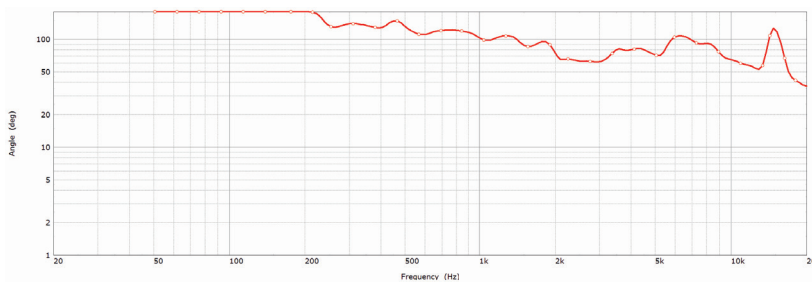

### Beamwidth -6dB

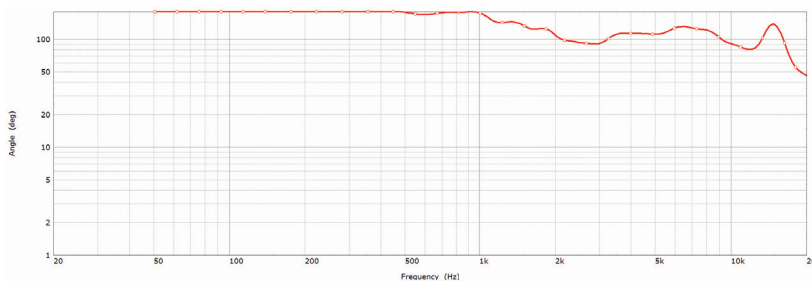

### Impedance

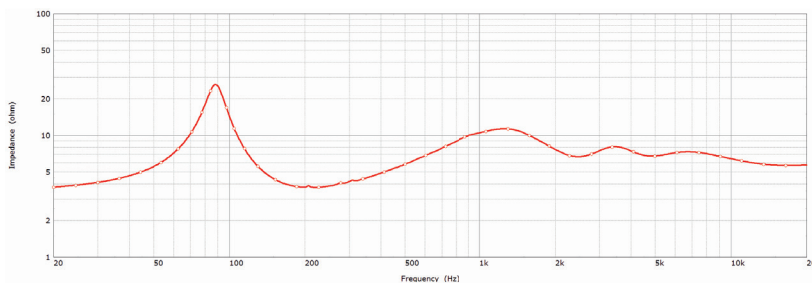

### Sensitivity (2.83V/1m)

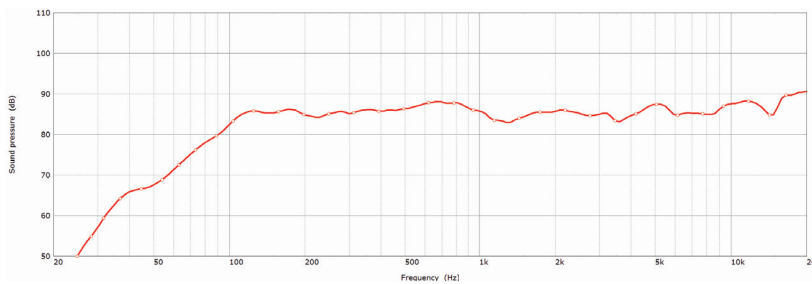

### Polar Responses

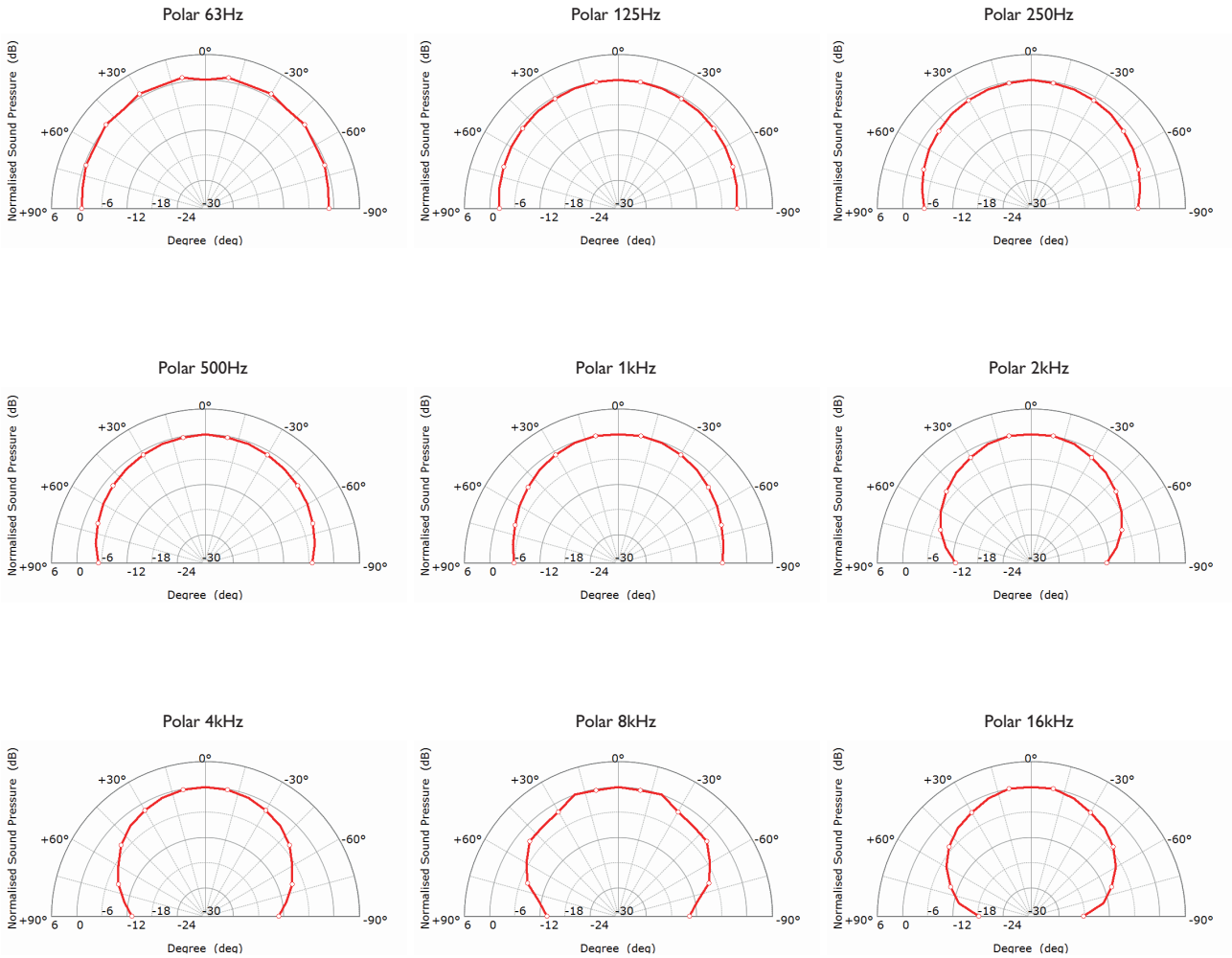

### Mechanical Diagrams

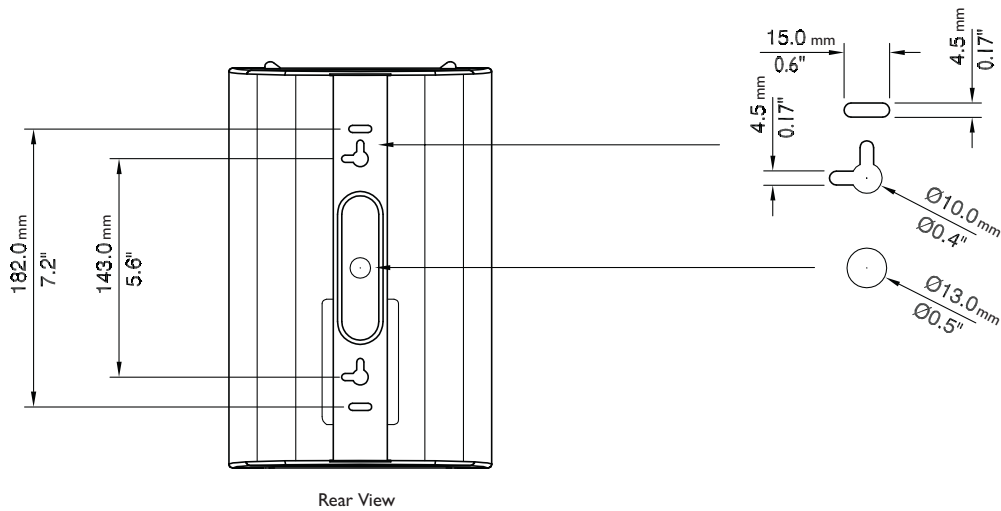
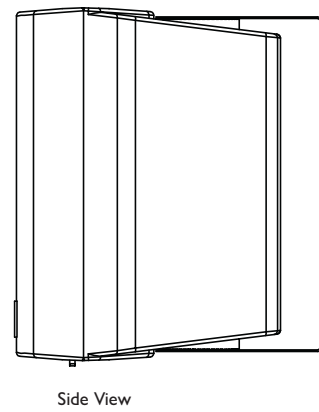
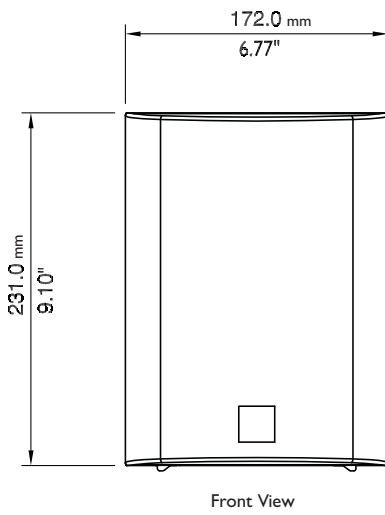
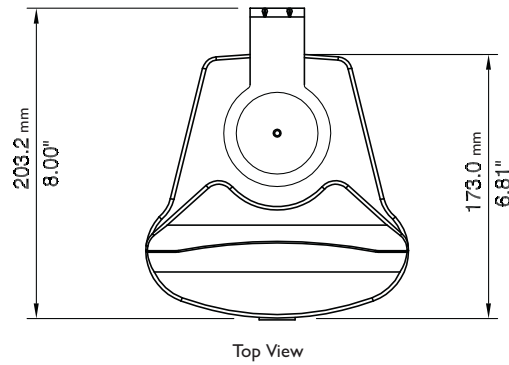

Dimensions in mm (inches)

KEF reserves the right, in line with continuing research and development, to amend or change specifications. E&OE.