

KEF

EGG Duo

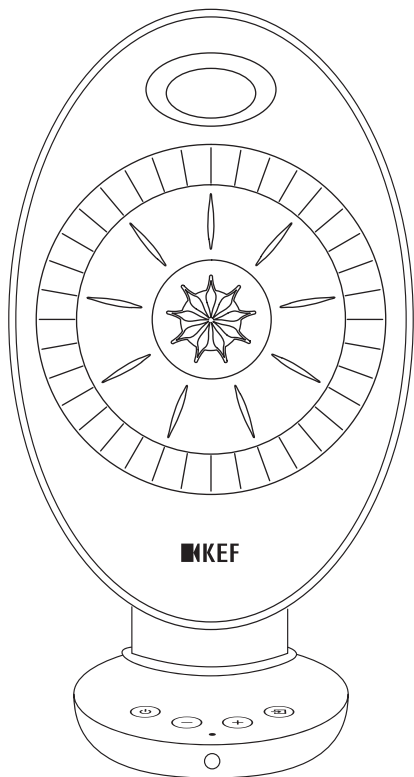

User Manual

QUICK START GUIDE

IN THE BOX

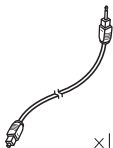
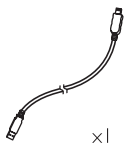
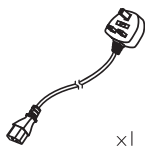
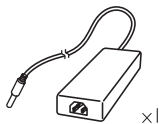
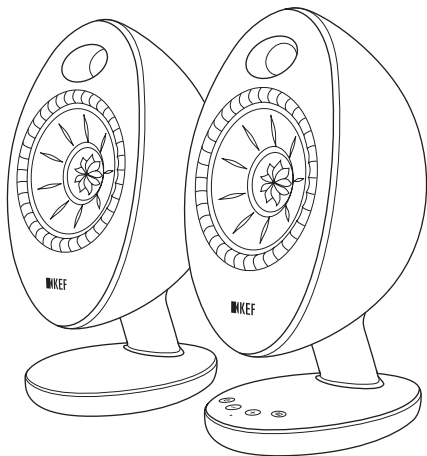

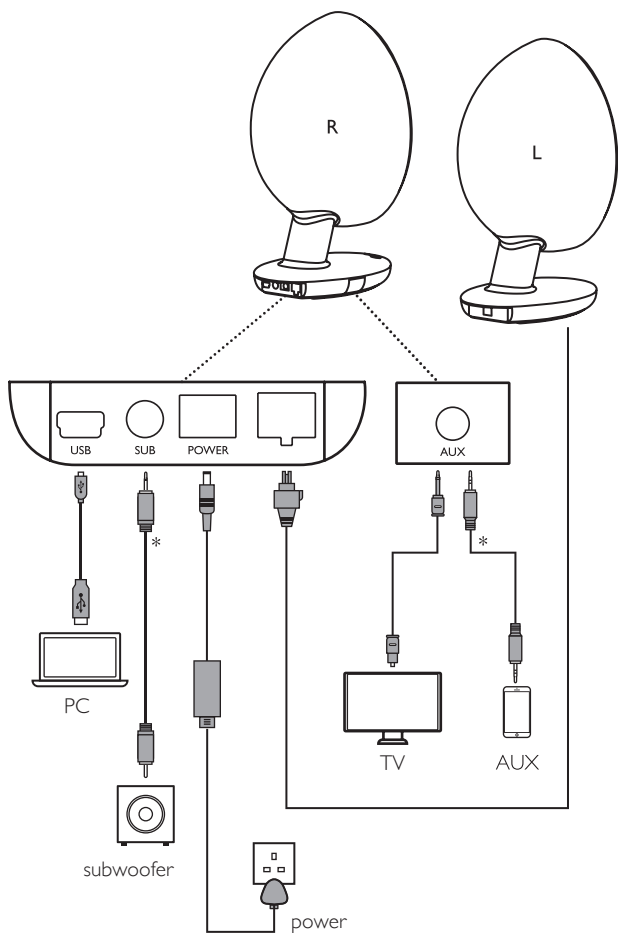

* Not included

I 

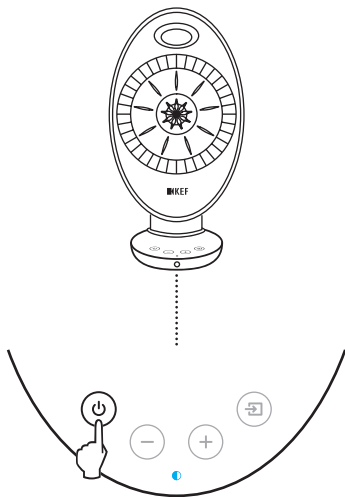

or



2 

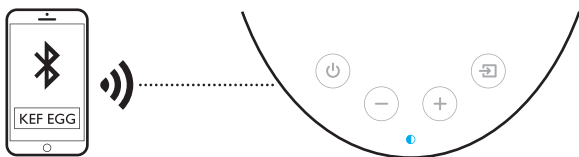
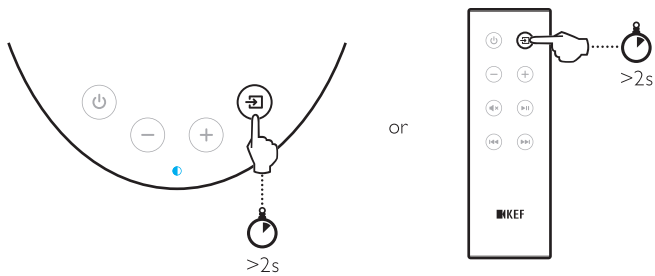

3 USB

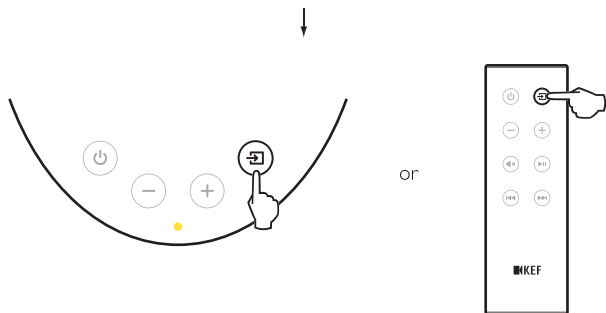
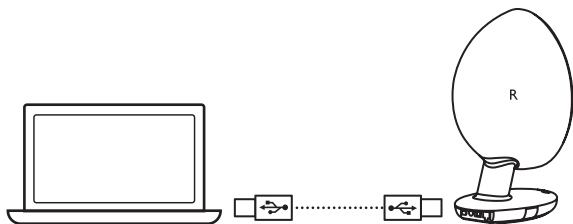

WINDOWS



MAC OS

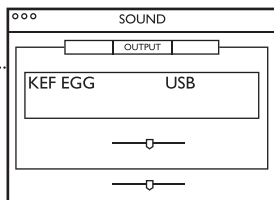
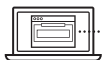

4 OTHER CONNECTIONS

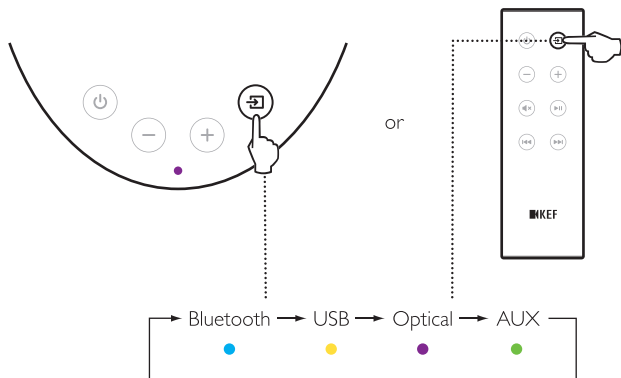

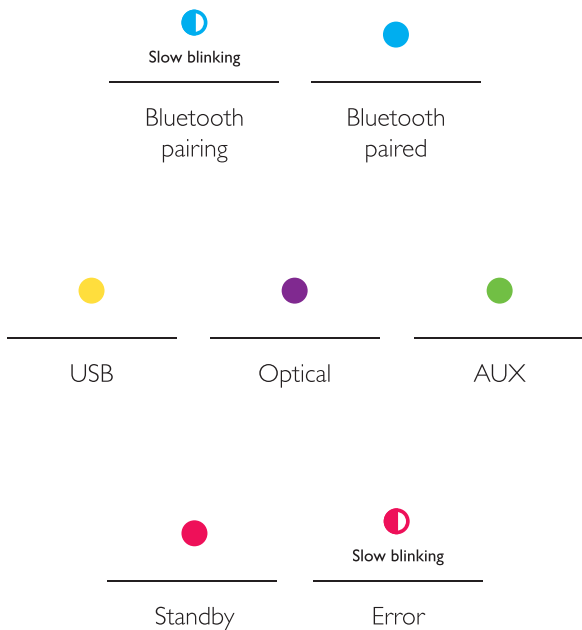

For further information and troubleshooting, please visit the KEF website: KEF.COM



MODEL	EGG Duo
DESIGN	Two-way bass reflex
DRIVE UNITS	Uni-Q driver array: HF: 19mm (0.75in.) vented aluminium dome MF: 115mm (4.25in.) aluminium
MAXIMUM OUTPUT (SPL)	95 dB
AMPLIFIER CLASS	Twin Class D
AMPLIFIER OUTPUT POWER	50 W
WIRELESS STANDARD	Bluetooth 4.0 with aptX® codec
ANALOG INPUT	3.5 mm AUX
DIGITAL INPUT	Mini USB Type B Mini TOSLINK Optical (combo jack)
RESOLUTION	Up to 24 bit
SAMPLING RATE	Up to 96 kHz, depending on source resolution
OUTPUT	Subwoofer output
AC POWER INPUT	100 - 240VAC 50 / 60 Hz
DIMENSION (H X W X D)	274 x 136 x 172 mm (10.8 x 5.4 x 6.8 in.)
WEIGHT	2.15 kg (4.74 lbs.) per speaker

The *Bluetooth*® word mark and logos are registered trademarks owned by Bluetooth SIG, Inc. Other trademarks and trade names are those of their respective owners.



The aptX® mark and the aptX logo are trade marks of CSR plc or one of its group companies and may be registered in one or more jurisdictions.



For further information and troubleshooting, please visit the KEF website: KEF.COM

KEF reserves the right, in line with continuous research and development, to amend or change specifications without prior notice. E. & O.E



型號	EGG Duo
設計	雙聲道低音反射式
驅動單體	Uni-Q 驅動單體配置: 高音: 19 mm (0.75 in.) 鋁製通風高音單體 中音: 115 mm (4.25 in.) 鋁材質
最大輸出 (SPL)	95 dB
擴大機種類	Twin Class D
擴大機輸出功率	50 W
無線標準	aptX® codec 藍芽 4.0
類比輸入	3.5 mm 插孔
數位輸入	USB: Mini USB Type B 連接器 數位光纖 (整合迷你插孔)
解析度	最高 24-bit
採樣比率	最高 96kHz, 根據音源解析
輸出	重低音輸出
AC 電源	100 - 240 VAC 50 / 60 Hz
尺寸(高 x 寬 x 深)	274 x 136 x 172 mm (10.8 x 5.4 x 6.8 in.)
重量	2.15 kg (4.74 lbs.) / 每一支喇叭

欲瞭解更多資訊和疑難排解，請至KEF網站：KEF.COM

鑒於持續的研發，KEF 保留修訂或變更規格的權利，恕不提前通知。E & O.E



型号	EGG Duo
设计	两路低音反射
驱动单元	Uni-Q 同轴共点单元: 高音单元: 19 mm (0.75 in.) 导管式铝膜球顶单元 中音单元: 115 mm (4.25 in.) 铝制单元
最大输出 (SPL)	95 dB
放大器类型	D 类双放大器
放大器输出功率	50 W
无线标准	Bluetooth 4.0 with aptX® codec
模拟输入	3.5 mm AUX
数字输入	B 型 Mini USB 接口 Mini TOSLINK 光纤接口(复合插孔)
精度	最高可达 24bit
采样率	最高可达 96kHz, 取决于音源精度
输出	超低音输出
交流电源输入	100 - 240 VAC 50 / 60 Hz
尺寸(高 x 宽 x 深)	274 x 136 x 172 mm (10.8 x 5.4 x 6.8 in.)
重量	2.15 kg (4.74 lbs.) 单只

如需了解更多信息和故障排除, 请访问KEF网站: KEF.COM

鉴于持续的研究与开发, KEF保留修改或变更产品规格的权利, 恕不提前通知。E&O.E

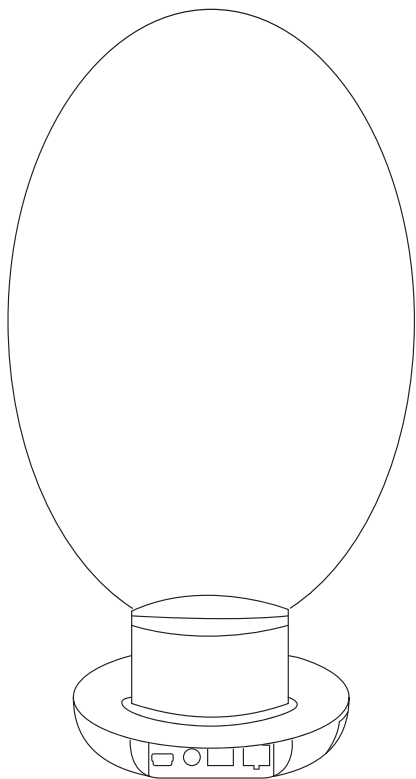

KEF.COM