

FRONT

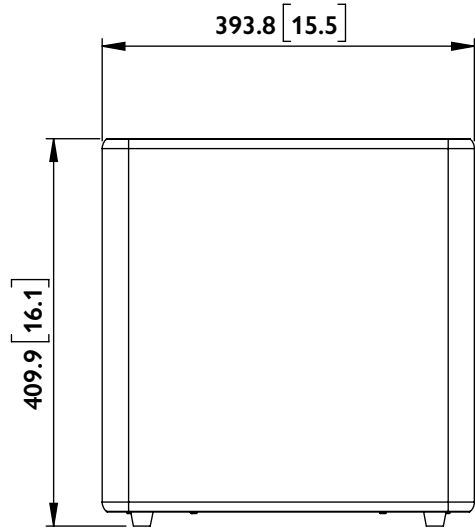

SIDE

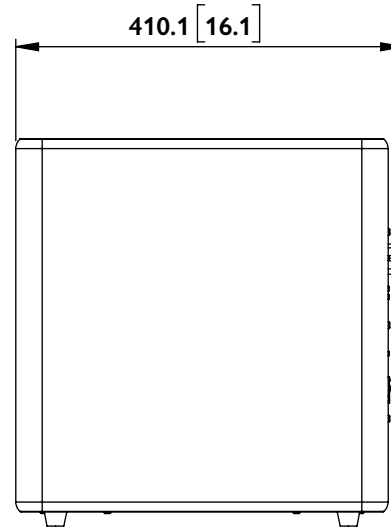

BACK

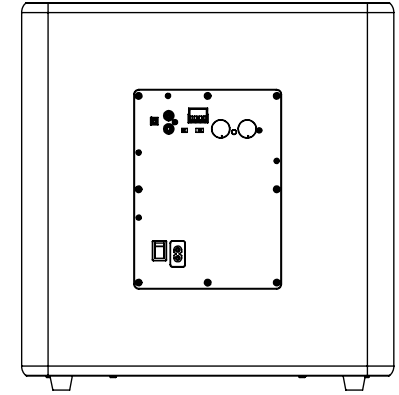

BOTTOM

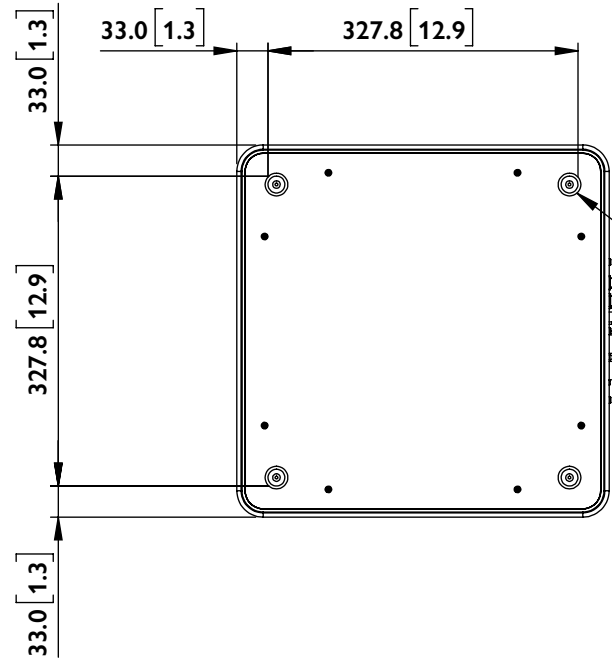

Feet thread size:
M3 x pitch 0.5

Kube 12b

UNIT: MM [INCH]